

325 and 328 Skid Steer Repair

TECHNICAL MANUAL
325 and 328 Skid Steer Repair
TM2192 09MAY18 (ENGLISH)

**Worldwide Construction
And Forestry Division**
PRINTED IN U.S.A.

Introduction

Foreword

This manual is written for an experienced technician. Essential tools required in performing certain service work are identified in this manual and are recommended for use.

Live with safety: Read the safety messages in the introduction of this manual and the cautions presented throughout the text of the manual.

 This is the safety-alert symbol. When you see this symbol on the machine or in this manual, be alert to the potential for personal injury.

Technical manuals are divided in two parts: repair and operation and tests. Repair sections tell how to repair the components. Operation and tests sections help you identify the majority of routine failures quickly.

Information is organized in groups for the various components requiring service instruction. At the beginning of each group are summary listings of all applicable essential tools, service equipment and tools, other materials needed to do the job, service parts kits, specifications, wear tolerances, and torque values.

Technical Manuals are concise guides for specific machines. They are on-the-job guides containing only the vital information needed for diagnosis, analysis, testing, and repair.

Fundamental service information is available from other sources covering basic theory of operation, fundamentals of troubleshooting, general maintenance, and basic type of failures and their causes.

TX,INTR,MB52 -19-12SEP97-1/1

Technical Information Feedback Form

We need your help to continually improve our technical publications. Please copy this page and FAX or mail your comments, ideas and improvements.

SEND TO: John Deere Dubuque Works
18600 South John Deere Road
Attn: Publications, Dept. 324
Dubuque, IA 52004-0538
USA

FAX NUMBER: 1-563-589-5800 (USA)

Publication Number: _____

Page Number: _____

Ideas, Comments: _____

Name: _____

Phone: _____

Email Address: _____

THANK YOU!

Introduction

Contents

Section 00—General Information

- Group 0001—Safety
- Group 0003—Torque Values

Section 01—Wheels

- Group 0110—Powered Wheels and Fastenings

Section 02—Axles and Suspension Systems

- Group 0201—Drive Axle Housing and Support
- Group 0250—Axle Shaft, Bearings and Reduction Gears

Section 03—Transmission

- Group 0315—Controls Linkage
- Group 0325—Flywheel Coupler
- Group 0360—Hydraulic System

Section 04—Engine

- Group 0400—Removal and Installation

Section 05—Engine Auxiliary Systems

- Group 0510—Cooling System
- Group 0515—Speed Control Group
- Group 0560—External Fuel Supply System

Section 17—Frame or Supporting Structure

- Group 1740—Frame Installation

Section 18—Operator's Station

- Group 1800—Removal and Installation
- Group 1810—Operator Enclosure
- Group 1821—Seat and Seat Belt
- Group 1830—Heating and Air Conditioning

Section 19—Sheet Metal and Styling

- Group 1910—Hood or Engine Enclosure

Section 31—Loader

- Group 3104—Attachment Coupler
- Group 3115—Control Linkage
- Group 3140—Frame
- Group 3160—Hydraulic System

Section 99—Dealer Fabricated Tools

- Group 9900—Dealer Fabricated Tools

Original Instructions. All information, illustrations and specifications in this manual are based on the latest information available at the time of publication. The right is reserved to make changes at any time without notice.

COPYRIGHT © 2018
DEERE & COMPANY
Moline, Illinois
All rights reserved.
A John Deere ILLUSTRATION™ Manual
Previous Editions
Copyright © 2004, 2006, 2007, 2008, 2009, 2010, 2012, 2014, 2016

**Thanks very much for your reading,
Want to get more information,
Please click here, Then get the complete
manual**

JustClickHere 

NOTE:

**If there is no response to click on the link above,
please download the PDF document first, and then
click on it.**

**Have any questions please write to me:
admin@servicemanualperfect.com**

Contents

Section 00
General Information

Contents

	Page		Page
Group 0001—Safety			
Recognize Safety Information	00-0001-1	Inch Series Four Bolt Flange Fitting	
Follow Safety Instructions.....	00-0001-1	For High Pressure Service	
Operate Only If Qualified	00-0001-1	Recommendations.....	00-0003-8
Wear Protective Equipment.....	00-0001-2	Service Recommendations For	
Avoid Unauthorized Machine		Inch Series Four Bolt Flange	
Modifications.....	00-0001-2	Fittings	00-0003-9
Inspect Machine	00-0001-2	Service Recommendation	
Stay Clear of Moving Parts.....	00-0001-2	O-Ring Face Seal Fittings with Metric Hex Nut and	
Avoid High-Pressure Oils	00-0001-3	Stud End for Standard Pressure.....	00-0003-10
Beware of Exhaust Fumes	00-0001-3	Service Recommendations for	
Prevent Fires	00-0001-4	Metric Series Four Bolt Flange	
Prevent Battery Explosions	00-0001-4	Fitting.....	00-0003-12
Handle Chemical Products Safely.....	00-0001-4		
Dispose of Waste Properly	00-0001-5		
Prepare for Emergencies.....	00-0001-5		
Use Steps and Handholds			
Correctly	00-0001-5		
Start Only From Operator's Seat	00-0001-5		
Use and Maintain Seat Belt.....	00-0001-6		
Prevent Unintended Machine			
Movement.....	00-0001-6		
Avoid Work Site Hazards.....	00-0001-6		
Keep Riders Off Machine	00-0001-7		
Avoid Backover Accidents	00-0001-7		
Avoid Machine Tip Over	00-0001-7		
Operating or Traveling On Public			
Roads	00-0001-8		
Add and Operate Attachments			
Safely.....	00-0001-8		
Park And Prepare For Service			
Safely.....	00-0001-8		
Service Cooling System Safely	00-0001-9		
Remove Paint Before Welding or			
Heating	00-0001-9		
Make Welding Repairs Safely	00-0001-9		
Drive Metal Pins Safely	00-0001-9		
Group 0003—Torque Values			
Torque Value			
Unified Inch Bolt and Cap Screw	00-0003-1		
Metric Bolt and Cap Screw.....	00-0003-2		
Additional Metric Cap Screw			
Torque Values.....	00-0003-3		
Check Oil Lines And Fittings	00-0003-4		
Service Recommendations for			
O-Ring Boss Fittings.....	00-0003-4		
Service Recommendations for			
37° Flare and 30° Cone Seat			
Connectors	00-0003-6		
Service Recommendations for			
Flared Connections—Straight or			
Tapered Threads	00-0003-7		

Contents

Recognize Safety Information

This is the safety alert symbol. When you see this symbol on your machine or in this manual, be alert for the potential of personal injury.

Follow the precautions and safe operating practices highlighted by this symbol.

A signal word — DANGER, WARNING, or CAUTION — is used with the safety alert symbol. DANGER identifies the most serious hazards.

On your machine, DANGER signs are red in color, WARNING signs are orange, and CAUTION signs are yellow. DANGER and WARNING signs are located near specific hazards. General precautions are on CAUTION labels.



MX10672,0000059 -19-09FEB04-1/1

T133555 —UN—15APR13

T133588 —19—28AUG00

Follow Safety Instructions

Read the safety messages in this manual and on the machine. Follow these warnings and instructions carefully. Review them frequently.

Be sure all operators of this machine understand every safety message. Replace operator's manual and safety labels immediately if missing or damaged.



TX03679,00016F9 -19-03JAN07-1/1

T133556 —UN—24AUG00

Operate Only If Qualified

Do not operate this machine unless the operator's manual has been read carefully, and you have been qualified by supervised training and instruction.

Operator should be familiar with the job site and surroundings before operating. Try all controls and

machine functions with the machine in an open area before starting to work.

Know and observe all safety rules that may apply to every work situation and work site.

TX03679,00016FA -19-03JAN07-1/1

Wear Protective Equipment

Guard against injury from flying pieces of metal or debris; wear goggles or safety glasses.

Wear close fitting clothing and safety equipment appropriate to the job.

Prolonged exposure to loud noise can cause impairment or loss of hearing. Wear suitable hearing protection such as earmuffs or earplugs to protect against objectionable or uncomfortable loud noises.

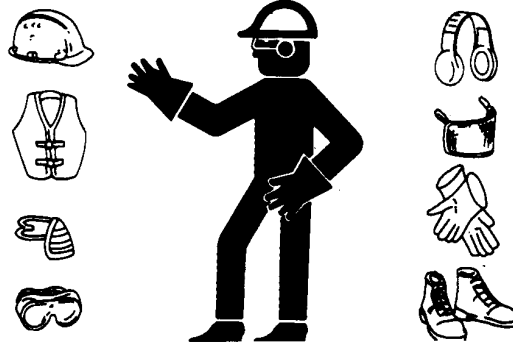

TS206—UN—15APR13

TX03679,00016D0 -19-03JAN07-1/1

Avoid Unauthorized Machine Modifications

Modifications of this machine, or addition of unapproved products or attachments, may affect machine stability or reliability, and may create a hazard for the operator or others near the machine. The installer of any modification which may affect this machine is responsible for establishing that the modification does not adversely

affect the machine or its performance. This applies to all aspects of the machine, including electronic controls.

Always contact an authorized dealer before making machine modifications that change the intended use, weight or balance of the machine, or that alter machine controls, performance or reliability.

TX14740,00000FC -19-27FEB04-1/1

Inspect Machine

Inspect machine carefully each day by walking around it before starting.

Inspect and Clean the Polycarbonate Windows. See Inspect and Clean Polycarbonate Windows. (Section 4-1.)

Keep all guards and shields in good condition and properly installed. Fix damage and replace worn or broken parts immediately. Pay special attention to hydraulic hoses and electrical wiring.



T6607AQ—UN—15APR13

TX03679,0001734 -19-17DEC14-1/1

Stay Clear of Moving Parts

Entanglements in moving parts can cause serious injury.

Stop engine before examining, adjusting or maintaining any part of machine with moving parts.

Keep guards and shields in place. Replace any guard or shield that has been removed for access as soon as service or repair is complete.

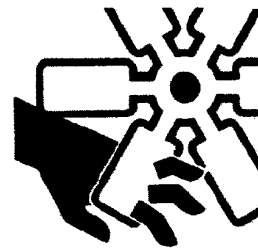

T133592—UN—15APR13

TX03679,00016D2 -19-03JAN07-1/1

Avoid High-Pressure Oils

This machine uses a high-pressure hydraulic system. Escaping oil under pressure can penetrate the skin causing serious injury.

Never search for leaks with your hands. Protect hands. Use a piece of cardboard to find location of escaping oil. Stop engine and relieve pressure before disconnecting lines or working on hydraulic system.

If hydraulic oil penetrates your skin, see a doctor immediately. Injected oil must be removed surgically within hours or gangrene may result. Contact a knowledgeable medical source or the Deere & Company Medical Department in Moline, Illinois, U.S.A.

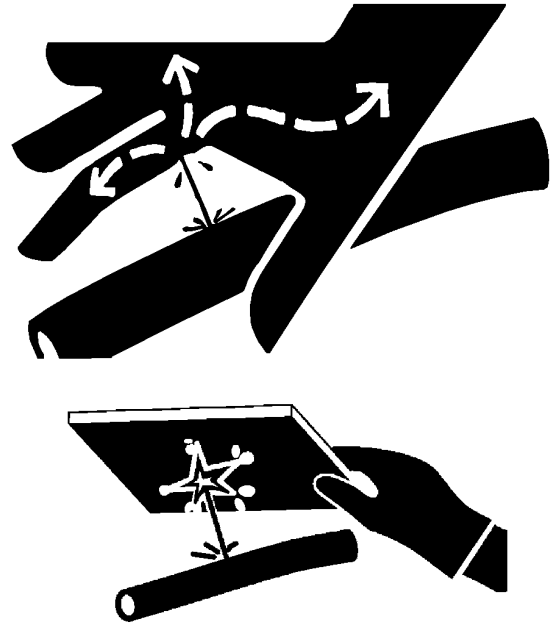

TX03679,00016D3 -19-03NOV08-1/1

T133509 —UN—15APR13

T133840 —UN—20SEP00

Beware of Exhaust Fumes

Prevent asphyxiation. Engine exhaust fumes can cause sickness or death.

If you must operate in an enclosed space, provide adequate ventilation. Use an exhaust pipe extension to remove the exhaust fumes or open doors and windows to bring outside air into the area.

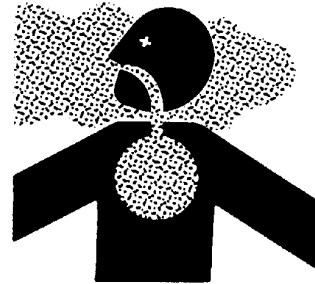

TX03679,00016D4 -19-03NOV08-1/1

T133546 —UN—24AUG00

Prevent Fires

Handle Fuel Safely: Store flammable fluids away from fire hazards. Never refuel machine while smoking or when near sparks or flame.

Clean Machine Regularly: Keep trash, debris, grease and oil from accumulating in engine compartment, around fuel lines, hydraulic lines and electrical wiring. Never store oily rags or flammable materials inside a machine compartment.

Maintain Hoses and Wiring: Replace hydraulic hoses immediately if they begin to leak, and clean up any oil spills. Examine electrical wiring and connectors frequently for damage.

Keep A Fire Extinguisher Available: Always keep a multi-purpose fire extinguisher on or near the machine. Know how to use extinguisher properly.

Keep Machine Away From Fire: Maintain a safe distance between sources of fire and the machine so elevated heat, flames or glowing embers never contact any part of the machine, including airborne glowing embers.



T133553 —UN—07SEP00

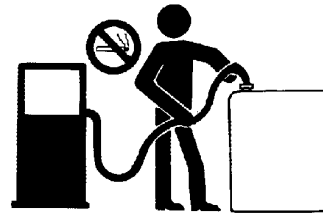

T133554 —UN—07SEP00

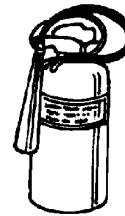

TX14740,00000FD -19-31JAN07-1/1

T133552 —UN—15APR13

Prevent Battery Explosions

Battery gas can explode. Keep sparks, lighted matches, and open flame away from the top of battery.

Never check battery charge by placing a metal object across the posts. Use a voltmeter or hydrometer.

Do not charge a frozen battery; it may explode. Warm battery to 16°C (60°F).



TX03679,000174A -19-03NOV08-1/1

TS204 —UN—15APR13

Handle Chemical Products Safely

Exposure to hazardous chemicals can cause serious injury. Under certain conditions, lubricants, coolants, paints and adhesives used with this machine may be hazardous.

If uncertain about safe handling or use of these chemical products, contact your authorized dealer for a Material Safety Data Sheet (MSDS). The MSDS describes physical and health hazards, safe use procedures, and emergency response techniques for chemical substances. Follow MSDS recommendations to handle chemical products safely.



TX03679,00016D7 -19-31JAN07-1/1

T133580 —UN—25AUG00

Dispose of Waste Properly

Improper disposal of waste can threaten the environment. Fuel, oils, coolants, filters and batteries used with this machine may be harmful if not disposed of properly.

Never pour waste onto the ground, down a drain, or into any water source.

Air conditioning refrigerants can damage the atmosphere. Government regulations may require using a certified service center to recover and recycle used refrigerants.

If uncertain about the safe disposal of waste, contact your local environmental or recycling center or your authorized dealer for more information.

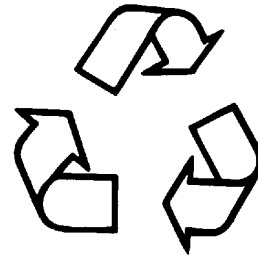

T133567 —UN—25AUG00

TX03679,0001733 -19-31JAN07-1/1

Prepare for Emergencies

Be prepared if an emergency occurs or a fire starts.

Keep a first aid kit and fire extinguisher handy.

Keep emergency numbers for doctors, ambulance service, hospital, and fire department near your telephone.

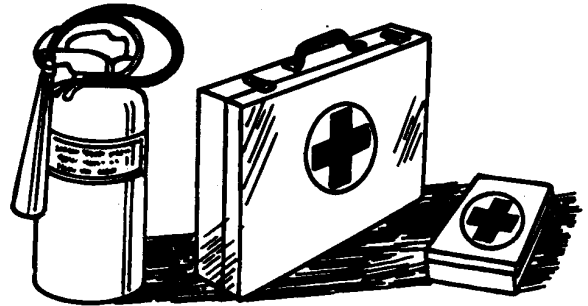

TS291 —UN—15APR13

TX03679,000174B -19-03NOV08-1/1

Use Steps and Handholds Correctly

Prevent falls by facing the machine when getting on and off. Maintain 3-point contact with steps and handrails. Never use machine controls as handholds.

Use extra care when mud, snow, or moisture present slippery conditions. Keep steps clean and free of grease or oil. Never jump when exiting machine. Never mount or dismount a moving machine.

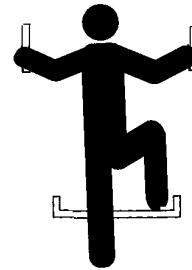

T133468 —UN—15APR13

TX03679,00016F2 -19-24APR13-1/1

Start Only From Operator's Seat

Avoid unexpected machine movement. Start engine only while sitting in operator's seat. Ensure all controls and working tools are in proper position for a parked machine.

Never attempt to start engine from the ground. Do not attempt to start engine by shorting across the starter solenoid terminals.



T133715 —UN—15APR13

TX03679,0001799 -19-22APR10-1/1

Use and Maintain Seat Belt

Use seat belt when operating machine. Remember to fasten seat belt when loading and unloading from trucks and during other uses.

Examine seat belt frequently. Be sure webbing is not cut or torn. Replace seat belt immediately if any part is damaged or does not function properly.

The complete seat belt assembly should be replaced every 3 years, regardless of appearance.



USE SEAT BELT

T133716 —19—17APR13

TX03679,00016DD -19-03NOV08-1/1

Prevent Unintended Machine Movement

Be careful not to accidentally actuate controls when co-workers are present.

Lower all equipment to the ground during work interruptions. Press park brake to park position “P” to engage park brake before allowing anyone to approach the machine.

Follow these same precautions before standing up, leaving the operator’s seat, or exiting the machine.



T194377A —UN—26AUG03

TX14740,000006A -19-09JUL03-1/1

Avoid Work Site Hazards

Avoid contact with gas lines, buried cables and water lines. Call utility line location services to identify all underground utilities before starting work.

Prepare work site properly. Avoid operating near structures or objects that could fall onto the machine. Clear away debris that could move unexpectedly if run over.

Avoid boom or attachment contact with overhead obstacles or overhead electrical lines. Never move machine closer than 3 m (10 ft) plus twice the line insulator length to overhead wires.

Keep bystanders clear at all times. Use barricades or a signal person to keep vehicles and pedestrians away. Use a signal person if moving machine in congested areas or where visibility is restricted. Always keep signal person in view. Coordinate hand signals before starting machine.

Operate only on solid footing with strength sufficient to support machine. Be especially alert working near embankments or excavations.

Avoid working under over-hanging embankments or stockpiles that could collapse under or on machine.

Reduce machine speed when operating with tool on or near ground when obstacles may be hidden (ie, during snow removal).

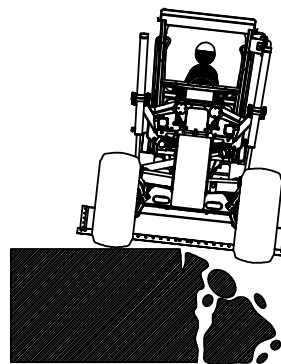
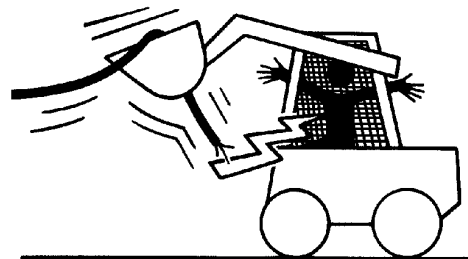

T192984 —UN—26AUG03

T141904 —UN—15MAY01

TX14740,00000FE -19-27FEB04-1/1

Keep Riders Off Machine

Only allow operator on machine.

Riders are subject to injury. They may fall from machine, be caught between machine parts, or be struck by foreign objects.

Riders may obstruct operator's view or impair their ability to operate machine safely.

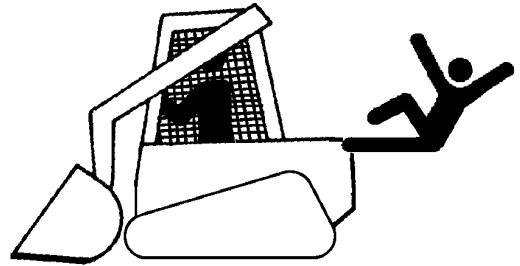

Keep Riders Off Machine

T211522 —UN—02JUN05

VD76477,0000045 -19-03SEP15-1/1

Avoid Backover Accidents

Before moving machine, be sure that all persons or vehicles are clear of machine path. Turn around and look directly for best visibility. Keep windows clean.

Be certain reverse warning alarm is working properly.

Use a signal person when backing if view is obstructed or when in close quarters. Keep signal person in view at all times. Use prearranged hand signals to communicate.



Avoid Backover Accidents

T211523 —UN—02JUN05

VD76477,0000044 -19-24MAY16-1/1

Avoid Machine Tip Over

Use seat belt at all times.

Do not jump if the machine tips. You will be unlikely to jump clear and the machine may crush you.

Load and unload from trucks or trailers carefully. Be sure truck is wide enough and on a firm level surface. Use loading ramps and attach them properly to truck bed.

Be careful on slopes. Avoid sharp turns. Balance loads so weight is evenly distributed and load is stable. Carry tools and loads close to the ground to aid visibility and lower center of gravity. Use extra care on wet, soft, rocky or frozen ground.

Know the capacity of the machine. Do not overload. Be careful with heavy loads. Using oversize buckets or lifting heavy objects reduces machine stability.

Ensure solid footing. Use extra care in soft ground conditions or on structures that may not uniformly support the wheels especially when raising the boom. Do not operate close to banks or open excavations that may cave in and cause machine to tip or fall.



**USE
SEAT
BELT**

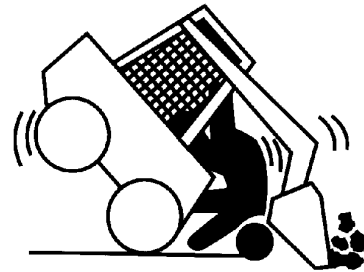

T133716 —19—17APR13

T1192979 —UN—26AUG03

TX14740,0000100 -19-27FEB04-1/1

Operating or Traveling On Public Roads

Machines that work near vehicle traffic or travel slower than normal highway speeds must have proper lighting and markings to assure they are visible to other drivers.

Install additional lights, beacons, slow moving vehicle (SMV) emblems, or other devices and use as required to make the machine visible and identify it as a work machine. Check state and local regulations to assure compliance. Keep these devices clean and in working condition.

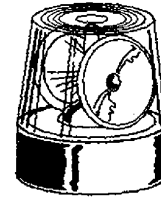
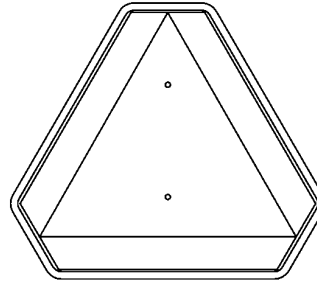

T141891 —UN—15APR13

TX17994,0000223 -19-11MAR02-1/1

Add and Operate Attachments Safely

Always verify compatibility of attachments by contacting your authorized dealer. Adding unapproved attachments may affect machine stability or reliability, and may create a hazard for others near the machine.

Ensure that a qualified person is involved in attachment installation. Add guards to machine if operator protection

is required or recommended. Verify that all connections are secure and attachment responds properly to controls.

Carefully read attachment manual and follow all instructions and warnings. In an area free of bystanders and obstructions, carefully operate attachment to learn its characteristics and range of motion.

TX17994,0000225 -19-09AUG06-1/1

Park And Prepare For Service Safely

Warn others of service work. Always park and prepare your machine for service or repair properly.

- Park machine on a level surface and lower equipment to the ground.
- Engage park brake. Stop engine and remove key.
- Attach a "Do Not Operate" tag in an obvious place in the operator's station.

Securely support machine or attachment before working under it.

- Do not support machine with any hydraulically actuated equipment.
- Do not support machine with cinder blocks or wooden pieces that may crumble or crush.
- Do not support machine with a single jack or other devices that may slip out of place.

Understand service procedures before beginning repairs. Keep service area clean and dry. Use two people whenever the engine must be running for service work.

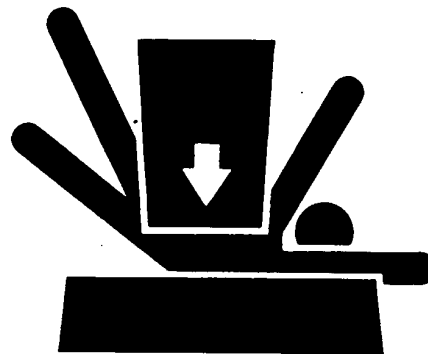
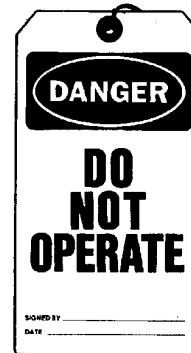

T133332 —19—17APR13

TS229 —UN—23AUG88

TX14740,0000101 -19-27FEB04-1/1

Service Cooling System Safely

Explosive release of fluids from pressurized cooling system can cause serious burns.

Shut off engine. Only remove filler cap when cool enough to touch with bare hands. Slowly loosen cap to first stop to relieve pressure before removing completely.

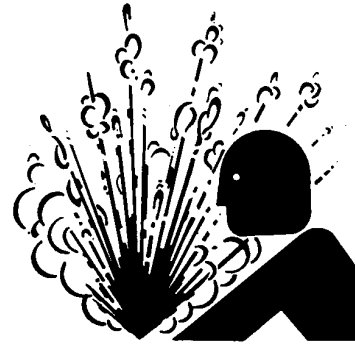

TS281 —UN—15APR13

TX17994,0000227 -19-11MAR02-1/1

Remove Paint Before Welding or Heating

Hazardous fumes can be generated when paint is heated by welding or using a torch. Dust from sanding or grinding paint can also be hazardous.

Remove paint to at least 76 mm (3 in.) from area to be heated. Wear an approved respirator when sanding or grinding paint. If a solvent or paint stripper is used, wash area with soap and water. Remove solvent or paint stripper containers from work area and allow fumes to disperse at least 15 minutes before welding or heating.

Work outside or in a well-ventilated area. Dispose of waste, paint and solvents properly.



T133546 —UN—24AUG00

TX17994,0000228 -19-11MAR02-1/1

Make Welding Repairs Safely

IMPORTANT: Disable electrical power before welding. Turn off main battery switch or disconnect positive battery cable. Separate harness connectors to engine and vehicle microprocessors.

Avoid welding or heating near pressurized fluid lines. Flammable spray may result and cause severe burns if pressurized lines fail as a result of heating. Do not let heat go beyond work area to nearby pressurized lines.

Remove paint properly. Do not inhale paint dust or fumes. Use a qualified welding technician for structural repairs.



Make sure there is good ventilation. Wear eye protection and protective equipment when welding.

T133547 —UN—15APR13

TX17994,0000229 -19-06FEB08-1/1

Drive Metal Pins Safely

Always wear protective goggles or safety glasses and other protective equipment before striking hardened parts. Hammering hardened metal parts such as pins and bucket teeth may dislodge chips at high velocity.

Use a soft hammer or a brass bar between hammer and object to prevent chipping.

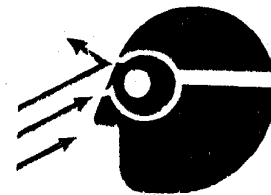

T133738 —UN—15APR13

TX17994,000022A -19-11MAR02-1/1

Safety

Group 003 Torque Values

Unified Inch Bolt and Cap Screw Torque Values

UNIFIED INCH BOLT AND CAP SCREW TORQUE VALUES—Tolerance is $\pm 10\%$ unless otherwise specified

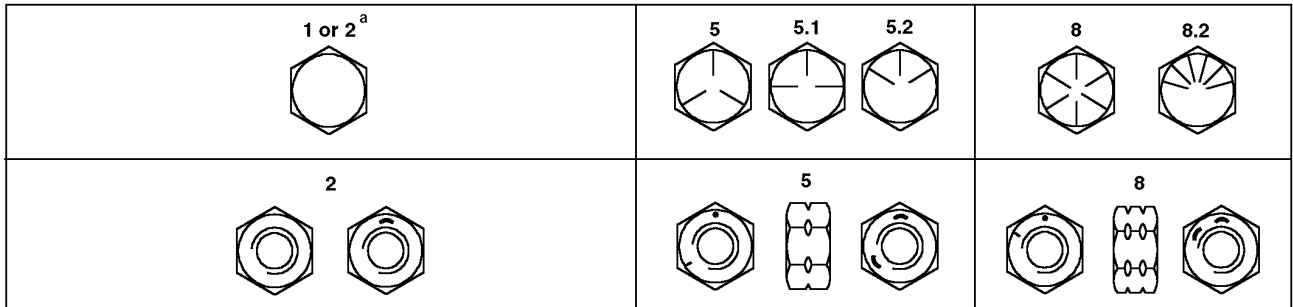

Top—SAE Grade and Head Markings; Bottom—SAE Grade and Nut Markings

Thread Size	Grade 1 (No Mark)		Grade 2 ^a (No Mark)		Grade 5, 5.1 or 5.2		Grade 8 or 8.2	
	Lubricated ^b N·m (lb-ft)	Dry ^c N·m (lb-ft)	Lubricated ^b N·m (lb-ft)	Dry ^c N·m (lb-ft)	Lubricated ^b N·m (lb-ft)	Dry ^c N·m (lb-ft)	Lubricated ^b N·m (lb-ft)	Dry ^c N·m (lb-ft)
1/4	3.8 (2.8)	4.7 (3.5)	6 (4.4)	7.5 (5.5)	9.5 (7)	12 (9)	13.5 (10)	17 (12.5)
5/16	7.7 (5.7)	9.8 (7.2)	12 (9)	15.5 (11.5)	19.5 (14.5)	25 (18.5)	28 (20.5)	35 (26)
3/8	13.5 (10)	17.5 (13)	22 (16)	27.5 (20)	35 (26)	44 (32.5)	49 (36)	63 (46)
7/16	22 (16)	28 (20.5)	35 (26)	44 (32.5)	56 (41)	70 (52)	80 (59)	100 (74)
1/2	34 (25)	42 (31)	53 (39)	67 (49)	85 (63)	110 (80)	120 (88)	155 (115)
9/16	48 (35.5)	60 (45)	76 (56)	95 (70)	125 (92)	155 (115)	175 (130)	220 (165)
5/8	67 (49)	85 (63)	105 (77)	135 (100)	170 (125)	215 (160)	240 (175)	305 (225)
3/4	120 (88)	150 (110)	190 (140)	240 (175)	300 (220)	380 (280)	425 (315)	540 (400)
7/8	190 (140)	240 (175)	190 (140)	240 (175)	490 (360)	615 (455)	690 (510)	870 (640)
1	285 (210)	360 (265)	285 (210)	360 (265)	730 (540)	920 (680)	1030 (760)	1300 (960)
1-1/8	400 (300)	510 (375)	400 (300)	510 (375)	910 (670)	1150 (850)	1450 (1075)	1850 (1350)
1-1/4	570 (420)	725 (535)	570 (420)	725 (535)	1280 (945)	1630 (1200)	2050 (1500)	2600 (1920)
1-3/8	750 (550)	950 (700)	750 (550)	950 (700)	1700 (1250)	2140 (1580)	2700 (2000)	3400 (2500)
1-1/2	990 (730)	1250 (930)	990 (730)	1250 (930)	2250 (1650)	2850 (2100)	3600 (2650)	4550 (3350)

^a Grade 2 applies for hex cap screws (not hex bolts) up to 6 in. (152 mm) long. Grade 1 applies for hex cap screws over 6 in. (152 mm) long, and for all other types of bolts and screws of any length.

^b "Lubricated" means coated with a lubricant such as engine oil, or fasteners with phosphate and oil coatings.

^c "Dry" means plain or zinc plated without any lubrication.

DO NOT use these values if a different torque value or tightening procedure is given for a specific application. Torque values listed are for general use only. Check tightness of fasteners periodically.

Shear bolts are designed to fail under predetermined loads. Always replace shear bolts with identical grade.

Fasteners should be replaced with the same or higher grade. If higher grade fasteners are used, these should only be tightened to the strength of the original.

Make sure fastener threads are clean and that you properly start thread engagement. This will prevent them from failing when tightening.

Tighten plastic insert or crimped steel-type lock nuts to approximately 50 percent of the dry torque shown in the chart, applied to the nut, not to the bolt head. Tighten toothed or serrated-type lock nuts to the full torque value.

OUT3035,TORQUE1 -19-14JAN04-1/1

Torque Values

Metric Bolt and Cap Screw Torque Values

METRIC BOLT AND CAP SCREW TORQUE VALUES—Tolerance is ±10% unless otherwise specified

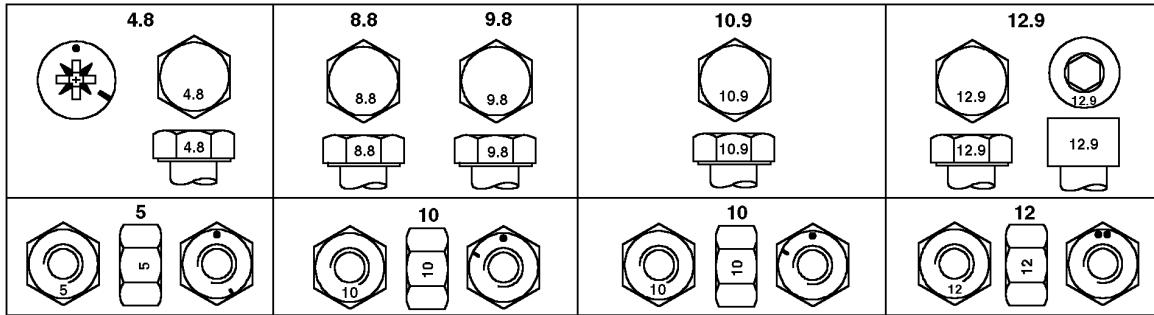

Top—Property Class and Head Markings; Bottom—Property Class and Nut Markings

Thread Size	Class 4.8		Class 8.8 or 9.8		Class 10.9		Class 12.9	
	Lubricated ^a N·m (lb-ft)	Dry ^b N·m (lb-ft)	Lubricated ^a N·m (lb-ft)	Dry ^b N·m (lb-ft)	Lubricated ^a N·m (lb-ft)	Dry ^b N·m (lb-ft)	Lubricated ^a N·m (lb-ft)	Dry ^b N·m (lb-ft)
M6	4.7 (3.5)	6 (4.4)	9 (6.6)	11.5 (8.5)	13 (9.5)	16.5 (12.2)	15.5 (11.5)	19.5 (14.5)
M8	11.5 (8.5)	14.5 (10.7)	22 (16)	28 (20.5)	32 (23.5)	40 (29.5)	37 (27.5)	47 (35)
M10	23 (17)	29 (21)	43 (32)	55 (40)	63 (46)	80 (59)	75 (55)	95 (70)
M12	40 (29.5)	50 (37)	75 (55)	95 (70)	110 (80)	140 (105)	130 (95)	165 (120)
M14	63 (46)	80 (59)	120 (88)	150 (110)	175 (130)	220 (165)	205 (150)	260 (190)
M16	100 (74)	125 (92)	190 (140)	240 (175)	275 (200)	350 (255)	320 (235)	400 (300)
M18	135 (100)	170 (125)	265 (195)	330 (245)	375 (275)	475 (350)	440 (325)	560 (410)
M20	190 (140)	245 (180)	375 (275)	475 (350)	530 (390)	675 (500)	625 (460)	790 (580)
M22	265 (195)	330 (245)	510 (375)	650 (480)	725 (535)	920 (680)	850 (625)	1080 (800)
M24	330 (245)	425 (315)	650 (480)	820 (600)	920 (680)	1150 (850)	1080 (800)	1350 (1000)
M27	490 (360)	625 (460)	950 (700)	1200 (885)	1350 (1000)	1700 (1250)	1580 (1160)	2000 (1475)
M30	660 (490)	850 (625)	1290 (950)	1630 (1200)	1850 (1350)	2300 (1700)	2140 (1580)	2700 (2000)
M33	900 (665)	1150 (850)	1750 (1300)	2200 (1625)	2500 (1850)	3150 (2325)	2900 (2150)	3700 (2730)
M36	1150 (850)	1450 (1075)	2250 (1650)	2850 (2100)	3200 (2350)	4050 (3000)	3750 (2770)	4750 (3500)

^a "Lubricated" means coated with a lubricant such as engine oil, or fasteners with phosphate and oil coatings.

^b "Dry" means plain or zinc plated without any lubrication.

CAUTION: Use only metric tools on metric hardware. Other tools may not fit properly. Tool may slip and cause injury.

DO NOT use these values if a different torque value or tightening procedure is given for a specific application. Torque values listed are for general use only. Check tightness of fasteners periodically.

Shear bolts are designed to fail under predetermined loads. Always replace shear bolts with identical property class.

Fasteners should be replaced with the same or higher property class. If higher property class fasteners are used, these should only be tightened to the strength of the original.

Make sure fastener threads are clean and that you properly start thread engagement. This will prevent them from failing when tightening.

Tighten plastic insert or crimped steel-type lock nuts to approximately 50 percent of the dry torque shown in the chart, applied to the nut, not to the bolt head. Tighten toothed or serrated-type lock nuts to the full torque value.

MX10672,0000075 -19-10FEB04-1/1

TORQ2—UN—15APR13

Additional Metric Cap Screw Torque Values

⚠ CAUTION: Use only metric tools on metric hardware. Other tools may not fit properly. They may slip and cause injury.

Check tightness of cap screws periodically. Torque values listed are for general use only. Do not use these values if a different torque value or tightening procedure is listed for a specific application.

Shear bolts are designed to fail under predetermined loads. Always replace shear bolts with identical grade.

Fasteners should be replaced with the same or higher grade. If higher grade fasteners are used, these should only be tightened to the strength of the original.

Make sure fastener threads are clean and that the thread engagement is properly started. This will prevent fasteners from failing when tightening.

Tighten cap screws having lock nuts to approximately 50 percent of amount shown in chart.

METRIC CAP SCREW TORQUE VALUES ^a						
Nominal Diameter	T-Bolt		H-Bolt		M-Bolt	
	N·m	lb·ft	N·m	lb·ft	N·m	lb·ft
8	29	21	20	15	10	7
10	63	46	45	33	20	15
12	108	80	88	65	34	25
14	176	130	137	101	54	40
16	265	195	206	152	78	58
18	392	289	294	217	118	87
20	539	398	392	289	167	125
22	735	542	539	398	216	159
24	931	687	686	506	274	202
27	1372	1012	1029	759	392	289
30	1911	1410	1421	1049	539	398
33	2548	1890	1911	1410	735	542
36	3136	2314	2401	1772	931	687

^aTorque tolerance is ±10%.

T6873AA

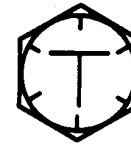

T-Bolt

T6873AB



H-Bolt

T6873AC



M-Bolt

T6873AA —UN—15APR13

T6873AB —UN—18OCT88

T6873AC —UN—18OCT88

Check Oil Lines And Fittings

⚠ CAUTION: Escaping fluid under pressure can penetrate the skin causing serious injury. Avoid the hazard by relieving pressure before disconnecting hydraulic or other lines. Tighten all connections before applying pressure. Search for leaks with a piece of cardboard. Protect hands and body from high pressure fluids.

If an accident occurs, see a doctor immediately. Any fluid injected into the skin must be surgically removed within a few hours or gangrene may result. Doctors unfamiliar with this type of injury may call the Deere & Company Medical Department in Moline, Illinois, or other knowledgeable medical source.

Check all oil lines, hoses, and fittings regularly for leaks or damage. Make sure all clamps are in position and tight. Make sure hoses are not twisted or touching moving machine parts. If abrasion or wear occurs, replace immediately.

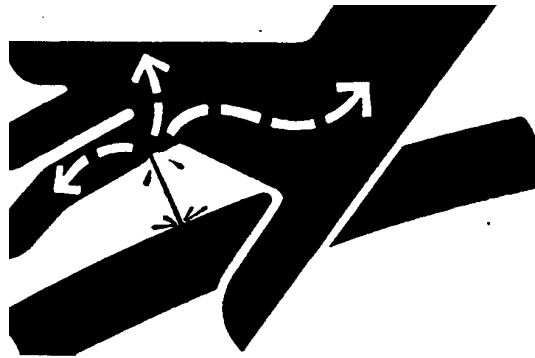

Tubing with dents may cause the oil to overheat. If you find tubing with dents, install new tubing immediately.

IMPORTANT: Tighten fittings as specified in torque chart.

When you tighten connections, use two wrenches to prevent bending or breaking tubing and fittings.

TX,90,DH1559 -19-01AUG94-1/1

X9811 —UN—23AUG88

Service Recommendations for O-Ring Boss Fittings

Straight Fitting

1. Inspect O-ring boss seat for dirt or defects.
2. Lubricate O-ring with petroleum jelly. Place electrical tape over threads to protect O-ring. Slide O-ring over tape and into O-ring groove of fitting. Remove tape.
3. Tighten fitting to torque value shown on chart.

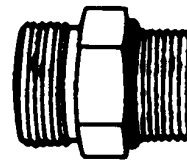

Straight Fitting

Continued on next page

04T,90,K66 -19-29SEP99-1/2

T6243AE —UN—15APR13